

Varenummer: 0108055
 Beskrivelse: Seeger låsering JK 38 DIN 984

Mål

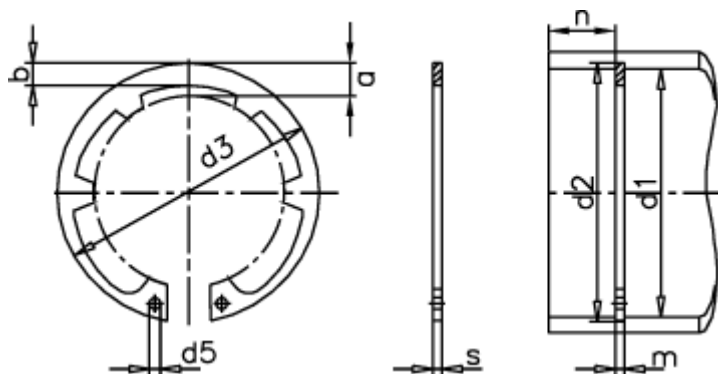

a max	= 6.1	d5 min	= 2.5	s	= 1.50
AN mm ²	= 123.0	FN kN	= 22.5	t	= 1.00
Antal takker	= 6	FRg kN	= 6.7	Tang	= ZGJ-2
b	= 38.0	FR kN	= 28.2	tol	= -0.06
Betegnelse	= JK 38	g	= 1.5	tol	= +0,50-0,25
d1	= 38	K kN-mm	= 51.7	tol	= +0,25
d2	= 40.0	m min	= 1.60	vægt kg/1000	= 4.40
d3	= 40.8	Nominal træk	= 3.0		